

Varenummer: 03552025

Beskrivelse: Fluro hydraulik ledhoved FPR 25N

Mål

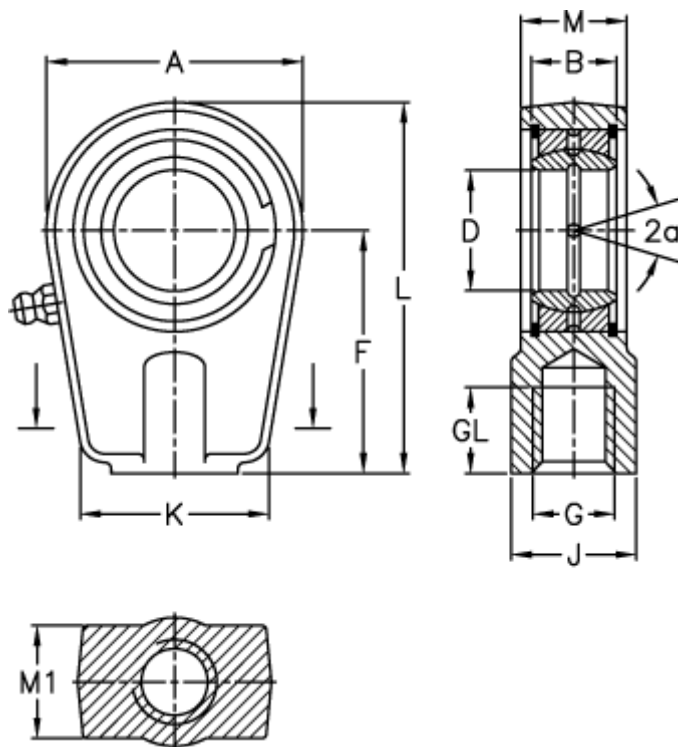

A	= 56	J	= 25
a (grader)	= 7	K	= 46
B	= 20	L	= 80
D	= 25	M	= 23
Dynamisk belastning C (kN)	= 48	M1	= 21
F	= 50	Statisk belastning C0 (kN)	= 72
g	= M16x1,5	Vægt	= 475
GL	= 17		